

INSTRUCTIONS AND REPAIR PARTS LIST

BRE224BID and PRE224BID STOCK TANK WITH BUILT-IN-DRINKER

READ ALL DIRECTIONS CAREFULLY BEFORE BEGINNING INSTALLATION

BRE224BID and PRE224BID Parts List

Ref. No.	Part No.	Description	Qty	Repair
1	BRE224BIDT	Tank, Poly, Red	1	
1	PRE224BIDT	Tank, Poly, Blue	1	
2	BRE224BIDP	Pan, Poly, Red	1	
2	PRE224BIDP	Pan, Poly, Blue	1	
BIDH - BID Hardware Box Contains Ref. Nos. 3-24				
3	PFGC	Pan Float Guard Cover, SS	1	*
4	PCGI	Inside Pan Chew Guard, SS	1	*
5	PCGO	Outside Pan Chew Guard, SS	1	*
6	OF360	#8 x 3/8" Hex Head Cap Screw, SS	2	*
7	OF358	5/16" Flat Washer, SS	5	*
8	OF350	1/4"-20 x 3/4" Hex Head Cap Screw, SS	5	*
9	OF348	1/4"-20 x 1/2" Hex Head Cap Screw, SS	2	*
10	OF349	1/4" Split Lockwasher, SS	2	*
11	OF306	1/4"-20 Hex Nut, SS	2	*
12	OP221	1 5/16" OD Hex Plug, Poly	1	*
B78P - Valve and Float Assembly Contains Ref. Nos. 13-24				
13	A15P	Hex Screen Filter, Poly	1	*
14	B83	3/4" Conduit Locknut, Zinc	1	*
15	A19	1-1/16" Washer, Fiber	1	*
16	OF51	#6-32 Hex Machine Nut, Brass	1	*
17	B80P	Hex Cone, Poly	1	*
18	B82	1/2" ID x 7/8" OD Washer, Rubber	1	*
19	B84P	Valve Body, Poly	1	*
20	3B1	Hook Rod, Brass	1	*
21	B100	1/8" x 1" Cotter Pin, Brass	1	*
22	W80B11P	Float Arm, Poly	1	*
23	OF116	1/4" External Tooth Lockwasher, SS	1	*
24	OP346	Float, Poly	1	*

Parts available for repair have an asterisk (*) in the repair column.

Valve Repair Packages - See Exhibit A

Part No.
B77P - Valve Only; Contains Ref. Nos. 13-20
B79P - Float and Float Arm; Contains Ref. Nos. 22-24
B81 - Hook, Rod, Cone Assembly; Contains Ref. Nos. 16, 17 & 20

EXHIBIT A - B78P Valve

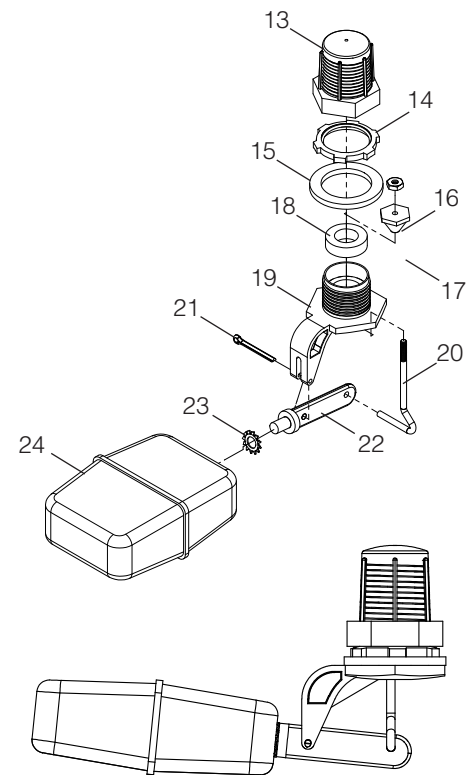

Note: The thinner tear-out distance of the W80B11P Float Arm should face upward.

MODEL NUMBER

The MODEL NUMBER is: BRE224BID and PRE224BID

WHEN ORDERING PARTS

- (1) Show MODEL NUMBER and NAME: Example - BRE224BID Stock Tank with Built-In Drinker
- (2) Show PART NUMBER and FULL DESCRIPTION of part: Example - PFGC Pan Float Guard Cover, SS

HOW TO ORDER PARTS

Repair parts may be ordered from your dealer.



PO BOX 2000 • HOUGHTON, IOWA 52631 • USA
PHONE: 319-469-4141 FAX: 319-469-4402
www.hawkeysteel.com E-MAIL: sales@hawkeysteel.com



ISHBID
REV. 3.2
PRINTED IN U.S.A.

EXHIBIT B

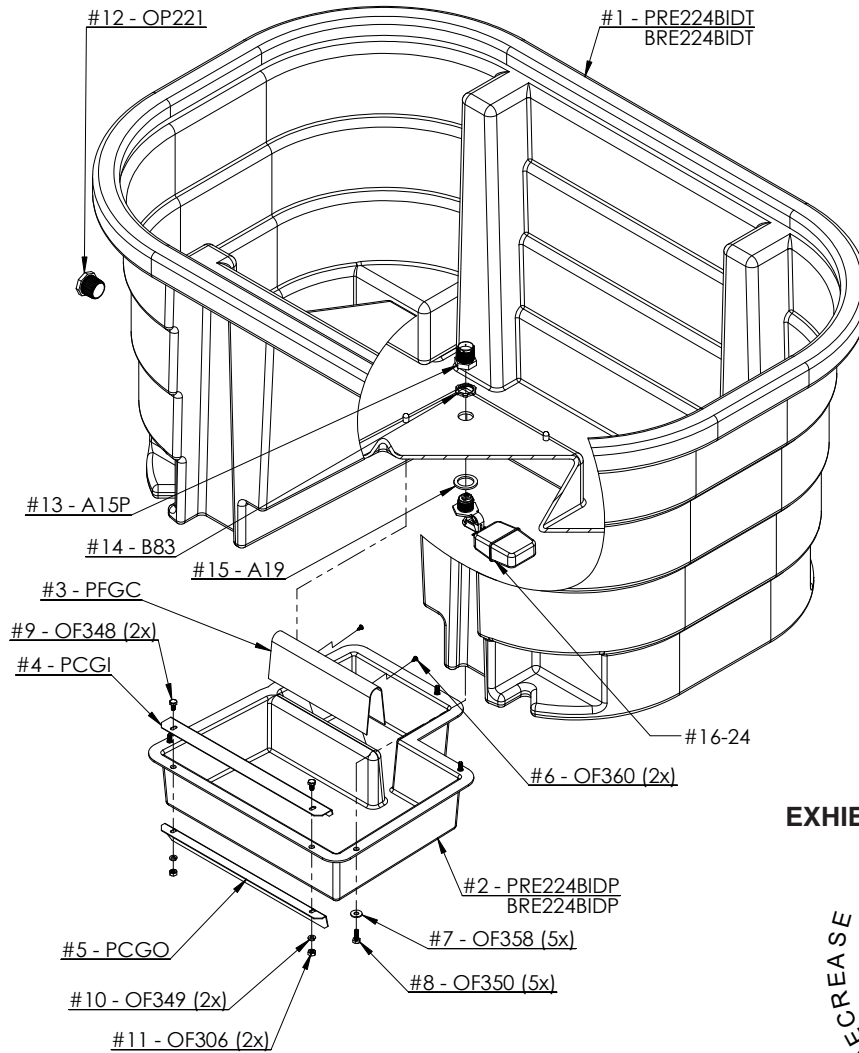
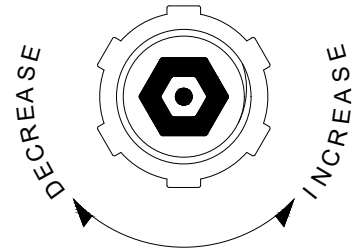

EXHIBIT C - Adjusting Water Level



ASSEMBLY INSTRUCTIONS

- STEP 1: Check the materials received against the parts list to ensure that all parts are present.
- STEP 2: Turn the Tank (Ref. No. 1) on its side. Locate the B78P Valve and Float Assembly (Ref. Nos. 13-24). Remove the Screen Filter (Ref. No. 13) and Locknut (Ref. No. 14). Insert the threaded portion of the valve through the hole in the Tank, leaving the Float (Ref. No. 24) on the outside bottom. Make sure the Float is turned parallel with the length of the tank. Thread the Locknut onto the Valve and tighten.

CAUTION: Do not overtighten or you may damage the valve.

- STEP 3: After the Valve and Float assembly is secure, thread the Screen Filter onto the Valve. This only needs to be finger tight.
- STEP 4: Slide Pan Float Guard Cover (Ref. No 3) over the plastic float guard in the Pan (Ref. No. 2). The holes in the cover should face toward the rear of the pan. Secure Cover with two (2) #8 Self-Tapping Screws (Ref. No. 6) screw through plastic. Snug but do not overtighten.
- STEP 5: Attach the both Inside and Outside Chew Guards (Ref. Nos. 4 & 5). Note the differences and orientation of each guard. The Inside Guard slots are centered.

The Outside Guard is slotted on the break. Sandwich the plastic lip of the Pan between the 2 Guards and secure using two (2) 1/4" x 1/2" Hex Bolt, 1/4" Split Lockwasher, and 1/4" Hex Nut (Ref. Nos. 9, 10 & 11). Tighten.

- STEP 6: Make sure the Valve Float is turned parallel with the Tank allowing the Pan to be inserted into the cavity in the Tank without any interference with the Float.
- STEP 7: Attach the Pan using 1/4" x 3/4" Hex Bolt and 1/4" Flat Washer (Ref. Nos. 7 & 8). Tighten.
- STEP 8: Your drinker is now ready to fill. It is recommended to fill the Tank halfway while adjusting the water level in the trough. When full, the recommended water level in the Base is 1" below the top edge of the trough. To increase the water level in the trough, remove the Screen Filter from the Valve and turn the end of the Hex Cone and #6 Machine Nut (Ref. No. 17 & 16) counter-clockwise. See Exhibit C. To decrease the water level, turn the end of the Hex Cone and #6 Machine Nut clockwise. After valve adjustment, be sure to screw the Screen Filter back onto the Valve.

Note: The Valve may slowly trickle for up to half an hour. During that time water level will slowly increase.